

CT202

Centrale per due motori 230 Vac (120 Vac), per cancelli a battente
Control unit for two 230 Vac (120 Vac) motors, for swing gates
Logique de commande pour deux moteurs 230 Vca (120 Vca), pour portails battants
Central para dos motores de 230 Vca (120 Vca) para puertas de batiente
Steuergerät für zwei Drehtor-Motoren 230 Vac (120 Vac)
Unidade para dois motores 230 Vac (120 Vac), para portões de batente
Centrala dla dwóch silników 230 Vac (120 Vac), do bram skrzydłowych

TABLE OF CONTENTS

1	Safety warnings	pag. 15
2	Product Introduction	pag. 16
2.1	Description of the control unit	pag. 16
2.2	Description of the connections	pag. 16
2.3	Models and technical characteristics	pag. 16
2.4	List of cables required	pag. 17
3	Preliminary Checks	pag. 17
4	Installing the Product	pag. 18
4.1	Electric connections	pag. 18
4.2	Display during normal operation	pag. 19
4.3	Autolearning of the travel stroke	pag. 20
4.4	Customising the system - BASIC MENU	pag. 22
4.5	Connecting the radio receiver	pag. 22
5	Testing and commissioning	pag. 23
5.1	Testing	pag. 23
5.2	Commissioning	pag. 23
6	Further details - ADVANCED MENU	pag. 24
7	Instructions and warnings for the final user	pag. 25
8	EC declaration of conformity	pag. 87

1 - SAFETY WARNINGS

CAUTION – to ensure personal safety it is important to follow these instructions and keep them for future reference.

Read the instructions carefully before proceeding with installation.

The design and manufacture of the devices making up the product and the information in this manual are compliant with current safety standards. However, incorrect installation or programming may cause serious injury to those working on or using the system. Compliance with the instructions provided here when installing the product is therefore extremely important.

If in any doubt regarding installation, do not proceed and contact the Key Automation Technical Service for clarifications.

Under European legislation, an automatic door or gate system must comply with the standards envisaged in the Directive 2006/42/EC (Machinery Directive) and in particular standards EN 12445; EN 12453; EN 12635 and EN 13241-1, which enable declaration of presumed conformity of the automation system.

Therefore, final connection of the automation system to the electrical mains, system testing, commissioning and routine maintenance must be performed by skilled, qualified personnel, in observance of the instructions in the "Testing and commissioning the automation system" section.

The aforesaid personnel are also responsible for the tests required to verify the solutions adopted according to the risks present, and for ensuring observance of all legal provisions, standards and regulations, with particular reference to all requirements of the EN 12445 standard which establishes the test methods for testing door and gate automation systems.

WARNING - Before starting installation, perform the following checks and assessments:

ensure that every device used to set up the automation system is suited to the intended system overall. For this purpose, pay special attention to the data provided in the "Technical specifications" section. Do not proceed with installation if any one of these devices is not suitable for its intended purpose;

check that the devices in the kit are sufficient to guarantee system safety and functionality;

perform a risk assessment, including a list of the essential safety requirements as envisaged in Annex I of the Machinery Directive, specifying the solutions adopted. The risk assessment is one of the documents included in the automation system's technical file. This must be compiled by a professional installer.

Considering the risk situations that may arise during installation phases and use of the product, the automation system must be installed in compliance with the following safety precautions:

never make any modifications to part of the automation system other than those specified in this manual. Operations of this type can only lead to malfunctions. The manufacturer declines all liability for damage caused by unauthorised modifications to products.

do not allow parts of the automation system to be immersed in water or other liquids. During installation ensure that no liquids are able to enter the various devices;

should this occur, disconnect the power supply immediately and contact a Key Automation Service Centre. Use of the automation system in these conditions may cause hazards;

never place automation system components near to sources of heat or expose them to naked flames. This may damage system components and cause malfunctions, fire or hazards.

All operations requiring opening of the protective housings of various automation system components must be performed with the control unit disconnected from the power supply. If the disconnect device is not in a visible location, affix a notice stating: "MAINTENANCE IN PROGRESS";

all devices must be connected to an electric power line equipped with an earthing system.

The product cannot be considered to provide effective protection against intrusion. If effective protection is required, the automation system must be combined with other devices;

the product may not be used until the automation system "commissioning" procedure has been performed as specified in the "Automation system testing and commissioning" section.

The system power supply line must include a circuit breaker device with a contact gap allowing complete disconnection in the conditions specified by class III overvoltage;

use unions with IP55 or higher protection when connecting hoses, pipes or raceways;

the electrical system upstream of the automation system must comply with the relevant regulations and be constructed to good workmanship standards;

users are advised to install an emergency stop button close to the automation system (connected to the control PCB STOP input) to allow the gate or door to be stopped immediately in case of danger;

this device product is not intended for use by persons (including children) with impaired physical, sensory or mental capacities, or with lack of experience or skill, unless a person responsible for their safety provides surveillance or instruction in use of the device;

children must be supervised to ensure that they do not play with the equipment.

WARNING - The automation system component packaging material must be disposed of in full observance of current local waste disposal legislation.

WARNING - The data and information in this manual are subject to modification at any time, with no obligation on the part of Key Automation S.r.l. to provide notice.

2 - INTRODUCING THE PRODUCT

2.1 - Description of the control unit

The CT202 control unit is a state-of-the-art efficient control system for Key Automation motors, for electrical opening and closing of swing gates.

Any other use is deemed improper and is strictly prohibited. The

CT202 control unit is equipped with a display to enable simple programming and constant monitoring of input status; the menu structure also enables easy entry of work times and operating logic.

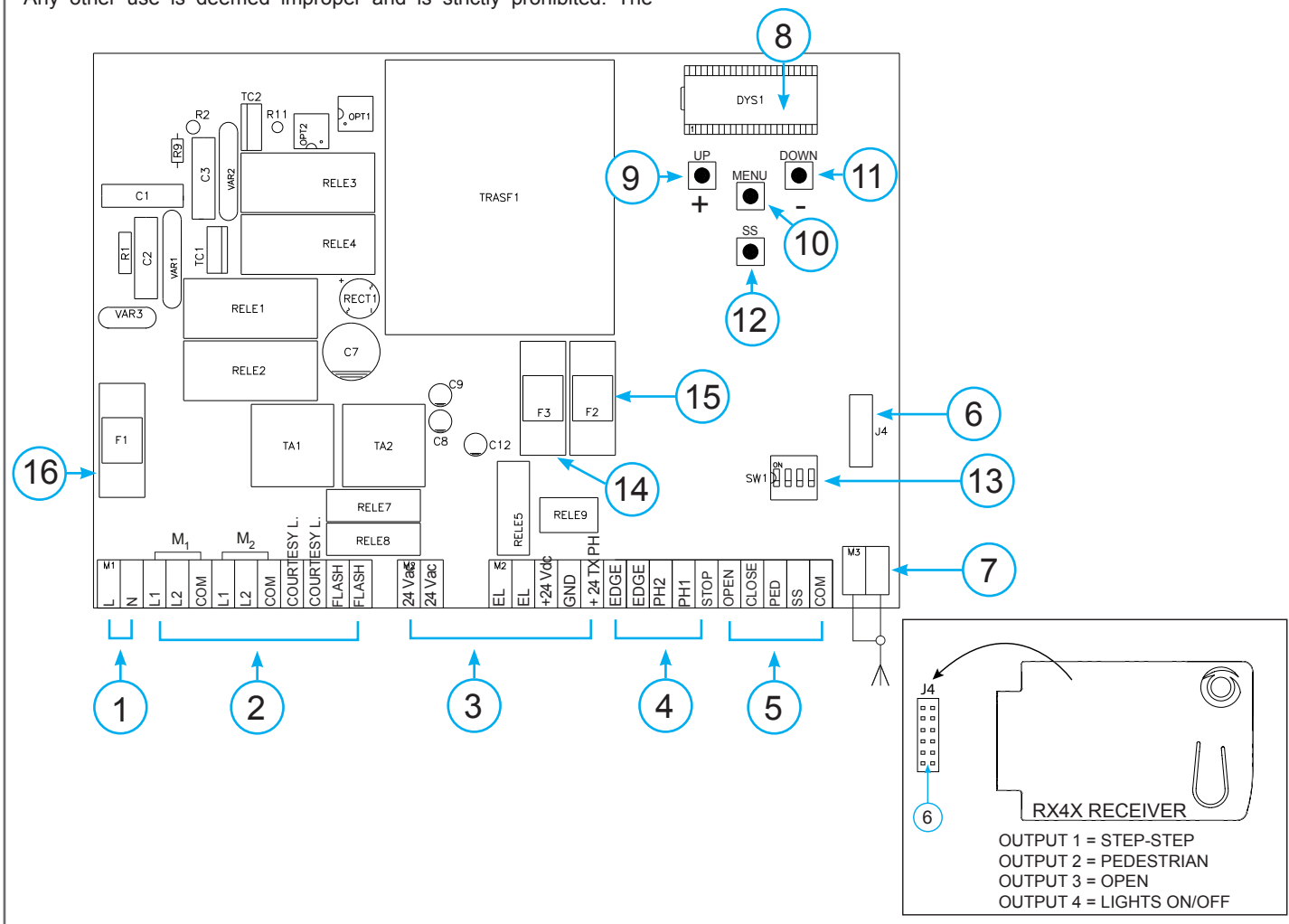

2.2 - Description of the connections

- 1- 230 Vac (120 Vac) power supply connections
- 2- Power supply connections for motors/capacitors/flashing lights and courtesy light
- 3- Connection of 24 Vdc/Vac power supplies for controls and safety devices
- 4- Connection of safety devices and signalling Leds RED EDGE PH2-PH1-STOP
- 5- Connection of control devices and signalling Leds GREEN OPEN-CLOSE-PED-SS
- 6- Connector for snap-fit RX4X radio board (4 channel)
- 7- Antenna connector

- 8- LCD display
- 9- UP + pushbutton
- 10- MENU pushbutton
- 11- DOWN - pushbutton
- 12- SS STEP STEP pushbutton
- 13- Safety device dip switch
- 14- F3- Safety fuse for AC accessories + electric lock 2 A quick acting
- 15- F2- Safety fuse for DC accessories 500 mA quick acting
- 16- F1- Safety fuse for power line 6.3 A quick acting

2.3 - Models and technical characteristics

CODE	DESCRIPTION
900CT202	Control unit for two 230V motors, for swing gates
900CT202V120	Control unit for two 120V motors, for swing gates

- Power supply with protection against short-circuits inside the control unit, on motors and on the connected accessories.
- Obstacle detection during travel at normal speed by means of current sensor.

- Automatic learning of working times.
- Safety device deactivation by means of dip switches: there is no need to bridge the terminals of safety devices which are not installed - the function is simply disabled by means of a dip switch.

TECHNICAL SPECIFICATIONS:		
Power supply (L-N)	230 Vac (+10% - 15%) 50-60 Hz	120 Vac (+10% - 15%) 50-60 Hz
Max motor load	700 W + 700 W	700 W + 700 W
Output for Vdc accessories power and device test power	24 Vdc 500 mA	24 Vdc 500 mA
Output for Vac accessories power	24 Vac 1 A	24 Vac 1 A
Courtesy light output	230 Vac 25 W	120 Vac 25 W
Flashing light output	230 Vac 25 W	120 Vac 25 W
Electric lock output	12 Vac / 15 VA	12 Vac / 15 VA
Maximum work time with settable nominal load	Adjustable	Adjustable
Pause time	Adjustable 0-900 sec.	Adjustable 0-900 sec.
Operating temperature	-20 °C + 55 °C	-20 °C + 55 °C
Power supply line fuses	6,3AF	6,3AF
Accessory fuses DC	500mAF	500mAF
Accessory fuses AC and electric lock	2AF	2AF

2.4 - List of cables required

The cables required for connection of the various devices in a standard system are listed in the cables list table.

The cables used must be suitable for the type of installation; for example, an H03VV-F type cable is recommended for indoor applications, while H07RN-F is suitable for outdoor applications.

ELECTRIC CABLE TECHNICAL SPECIFICATIONS:

Connection	cable	maximum allowable limit
Power supply line	1 x cable 3 x 1,5 mm ²	20 m *
Motor power supply line	1 x cable 4 x 1,5 mm ²	20 m
Flashing light, courtesy light	1 x cable 4 x 0,5 mm ² **	20 m
Antenna	1 x cable type RG58	20 m (advised < 5 m)
Electric lock	1 x cable 2 x 1 mm ²	20 m
Transmitter photocells	1 x cable 2 x 0,5 mm ²	20 m
Receiver photocells	1 x cable 4 x 0,5 mm ²	20 m
Sensitive edge	1 x cable 2 x 0,5 mm ²	20 m
Key-switch	1 x cable 4 x 0,5 mm ²	20 m

* If the power cable is longer than 30 m, a cable with a larger cross-section is required (3x2.5 mm²) and safety earthing is necessary in the vicinity of the automation.

** Two cables of 2 x 0.5 mm² can be used as an alternative

3 - PRELIMINARY CHECKS

Before installing the product, perform the following checks and inspections:

check that the gate or door is suitable for automation;

the weight and size of the gate or door must be within the operating limits specified for the automation system in which the product is installed;

check that the gate or door has firm, effective mechanical safety stops;

make sure that the product fixing zone is not subject to flooding;

high acidity or salinity or nearby heat sources might cause the product to malfunction;

in case of extreme weather conditions (e.g. snow, ice, wide temperature variations or high temperatures), friction may increase, causing a corresponding rise in the force needed to operate the system;

the starting torque may therefore exceed that required in normal conditions;

check that when operated by hand the gate or door moves smoothly without any areas of greater friction or derailment risk;

check that the gate or door is well balanced and will therefore remain stationary when released in any position;

check that the electricity supply line to which the product is to be connected is suitably earthed and protected by an overload and differential safety breaker device;

the system power supply line must include a circuit breaker device with a contact gap allowing complete disconnection in the conditions specified by class III overvoltage;

ensure that all the material used for installation complies with the relevant regulatory standards.

4 - PRODUCT INSTALLATION

4.1 - Electrical connections

WARNING - Before making the connections, ensure that the control unit is not powered up.

POWER SUPPLY CONNECTOR AND MOTOR		
L	230 Vac (120 Vac) 50-60 Hz power supply phase	
N	230 Vac (120 Vac) 50-60 Hz power supply neutral	
M1	L1	Motor phase
	L2	Motor phase
	COM	Motor common
M2	L1	Motor phase
	L2	Motor phase
	COM	Motor common
COURTESY L.	Courtesy light, 230 Vac (120 Vac) 100 W, output controllable also via radio ON-OFF command (radio channel 4 selecting F.C.Y. = 2, E.C.Y. = 0)	
FLASH	Flashing light, 230 Vac (120 Vac) 40 W	

POWER SUPPLY CONNECTOR

Set on "ON" to disable inputs EDGE, PH2, PH1, STOP. Eliminates the need to bridge the terminal board inputs.

WARNING - with the dip switch ON, the safety devices are disabled

1 = EDGE
2 = FOTO 2
3 = FOTO 1
4 = STOP

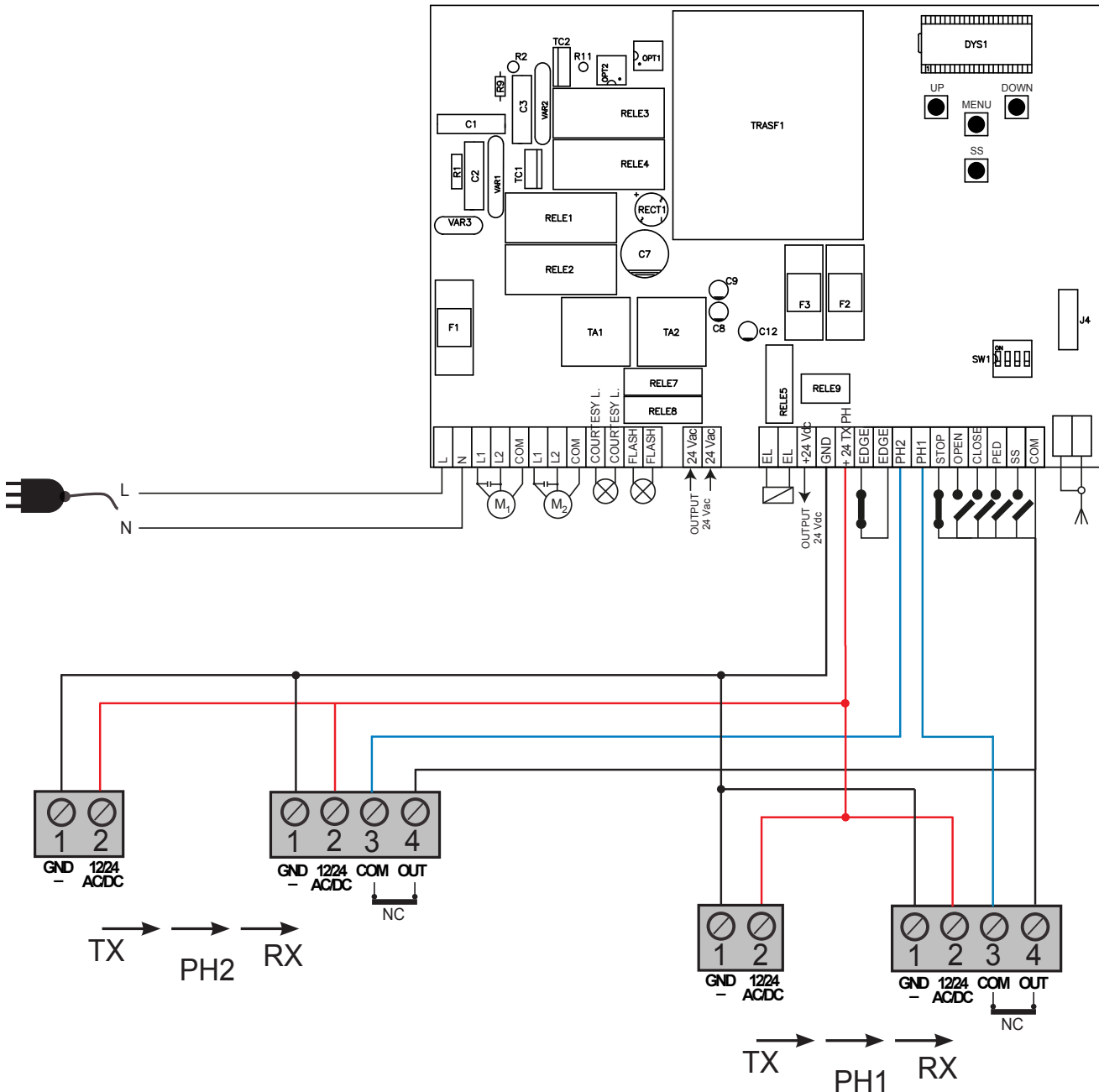

SAFETY AND CONTROL DEVICE CONNECTOR

24 Vac	Accessories power 24 Vac, 1 A
EL 12 Vac	Electric lock output 12 Vac / 15 VA
+24 Vdc	Accessories power positive 24 Vdc, 500 mA
GND	Accessories power negative 24 Vdc, 500 mA
+ 24 Vdc TX PHOTO	Power positive for photocells PH1, PH2; fototest selectable with parameter t_{Ph}
EDGE	Safety edge, ON/OFF NC or 8K2 contact between EDGE and EDGE (caution: when dip switch 1 is set to ON this disables the EDGE safety input)
PH2	Photocells (opening) NC contact between PH2 and COM (caution: when dip switch 2 is set to ON this disables the PHOTO-CELL 2 safety input). The photocells trip at any time during automation opening, causing immediate shutdown of the motor; the automation continues opening on reset of the contact. During closing the photocell trips causing immediate shutdown of movement; the automation inverts movement to opening when the contact is reset.
PH1	Photocells (closing) NC contact between PH1 and COM (caution: when dip switch 3 is set to ON this disables the PHOTO-CELL 1 safety input). The photocell trips at any time during automation closing, causing immediate shutdown of movement and inverting the direction of travel; this photocell is not enabled during opening.
STOP	STOP safety device, NC contact between STOP and COM (warning, with dip switch 4 ON the STOP safety device input is off) This input is classified as a safety device; the contact can be deactivated at any time, cutting out the automation system and disabling all functions, including Automatic Closure
OPEN	OPEN command NO contact between OPEN and COM Contact for the HOLD-TO-RUN function. The gate OPENS as long as the contact is held down
CLOSE	CLOSE command NO contact between CLOSE and COM Contact for the HOLD-TO-RUN function. The gate CLOSES as long as the contact is held down
PED	PEDESTRIAN command NO contact between PED and COM Used to open the gate partially, depending on the software setting
SS	STEPPING command NO contact between SS and COM Open/Stop/Close/Stop command, or as set in the software
COM	Common for the PH1, PH2, STOP, OPEN, CLOSE, PED and SS inputs
SHIELD	Antenna - sheath -
SIGNAL	Antenna - signal -

4.2 - Display during normal operation

In "NORMAL OPERATING MODE", i.e. when the system is powered up normally, the 3-figure LCD display shows the following status messages:

MESSAGES	MEANING
--	Gate closed or switch-on after shutdown
OP	Gate opening
CL	Gate closing
SO	Gate stopped during opening
SC	Gate stopped during closure
HA	Gate stopped by external event
oP	Gate stopped without automatic reclosure
PE	Gate in pedestrian opening position without automatic reclosure
-tL	Gate open with timed reclosure Flashing dash counting in progress Dash replaced by figures 0..9 countdown (last 10s)
-tP	Gate in pedestrian opening position with timed reclosure Flashing dash counting in progress Dash replaced by figures 0..9 countdown (last 10s)
L--	Control unit ready for travel learning cycle
LOP	Learning opening
LCL	Learning closure

Malfunctions

This section lists a number of malfunctions which may occur.

SURGE OVERLOAD ALARM	The motor's current drawdown has increased very quickly
<i>EFO</i>	1. Leaf impact with obstacle. 2. Gate rubs during opening/closing
SAFETY EDGE ALARM	The control unit has received a signal from the safety edge
<i>EEd</i>	1. The safety edge has been pressed. 2. The safety edge is not connected correctly.
PHOTOCELL ALARM	Phototest fail outcome
<i>EPH</i>	1. Check the photocell connections. 2. Check that the photocells are operating correctly.
ELECTRONIC OVERLOAD CUTOUT TRIPPED	Motor not absorbing power
<i>Eth</i>	1. Check the motor's power drawdown. 2. Check that the gate travels smoothly and that there are no obstacles.

After eliminating the cause of the alarm, to delete all errors simply press the "DOWN -" key or press the SS (STEPPING) command

The display returns to the normal screen.

4.3 - Autolearning of the travel stroke

The first time the control unit is powered up, an autolearning procedure must be carried out to acquire fundamental parameters such as the travel stroke length and deceleration points. Press the + or - keys to view not only the status of the control unit, as

explained in the first table in point 4.2, but also the count of the opening-closing operations performed. In the operation count display, thousands, displayed without dots, alternate with units, displayed with dots between them (e.g.: 50.000 = 50/0.0.0).

AUTOLEARNING OF THE TRAVEL STROKE AND MAIN PARAMETERS, WITH PRESET DECELERATIONS

The deceleration intervals are as set in the menu, with the same percentage applied during opening and closing.

CAUTION: if manual programming of deceleration intervals is required, go to the next table

1. CAUTION! check that mechanical end stops (compulsory) are present and secure. The motors must always reach the mechanical end stop

2. Move the gate manually to mid-travel.

3. Press the pushbuttons UP + and MENU at the same time for at least 5 seconds until *LDP* is displayed, then (if necessary) press DOWN (see figure).

Ensure that motor M1 is activated first; otherwise, press DOWN -, turn the power off and invert connections M1 and M2. Repeat the procedure from step 3.

If the first manoeuvre is NOT opening, press DOWN - to stop the self-learning process. Then press SS to restart acquisition: the leaf resumes movement in the correct direction.

4. Motor M1 opens at low speed until it reaches the mechanical opening end stop.

At precisely the time of reaching the mechanical opening end stop, press the SS command.

Motor M2 starts automatically in opening mode. If motor M2 moves in closing, stop by pressing DOWN - and resume movement using SS (the leaf resumes movement in the correct direction)

5. Motor M2 opens at low speed. **At precisely the time of reaching the mechanical opening end stop, press the SS command.** After a couple of seconds, motor M2 starts automatically in closing at full speed.

6. **Precisely when motor M2 reaches the closed position, press the SS command.** Motor M2 stops and motor M1 starts in closing.

7. **Precisely when motor M1 reaches the closed position, press the SS command.** Motor M1 stops and restarts in opening.

8. **Precisely when motor M1 reaches the open position, press the SS command.** Motor M1 stops and motor M2 starts in opening.

9. **Precisely when motor M2 reaches the open position, press the SS command.** Motor M2 stops.

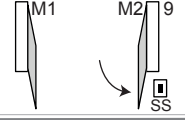
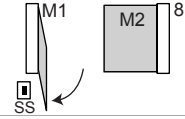
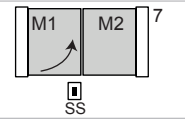
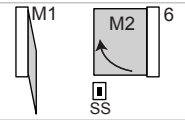
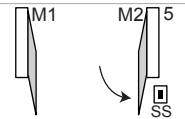
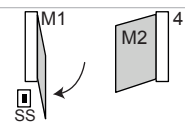
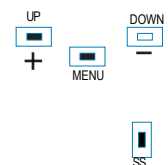
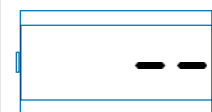

10. Motors M1 and M2 resume closing according to the leaf offset values set in the menu, i.e. the gate closes automatically according to the set travel.

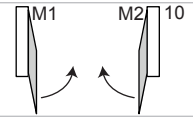

11. Run a number of opening, closing and stop manoeuvres, to check that the system is stable and there are no assembly defects.

All main parameters are configured as default by the control unit. To personalise installation, go to the next step in paragraph 4.4. If torque

is not sufficient to move the leaf, delete the deceleration intervals from the menu [$L5i = 0$].

AUTOLEARNING OF THE TRAVEL STROKE AND MAIN PARAMETERS, WITH CUSTOMISED DECELERATIONS

Deceleration intervals can be personalised by the user, according to the procedure below.

1. CAUTION! check that mechanical end stops (compulsory) are present and secure. The motors must always reach the mechanical end stop

2. Move the gate manually to mid-travel.

3. CAUTION: enter the main menu to set the parameter $L5i = P$ as per the table in paragraph 4.4

4. Press the pushbuttons UP + and MENU at the same time for at least 5 seconds until LDP is displayed, then (if necessary) press DOWN - (see figure).

Ensure that motor M1 opens first; otherwise, press DOWN -, turn the power off and invert connections M1 and M2. Repeat the procedure from step 4.

If the first manoeuvre is NOT opening, press DOWN - to stop the self-learning process. Then press SS to restart acquisition: the leaf resumes movement in the correct direction.

5. Motor M1 opens at low speed until it reaches the mechanical opening end stop.

At precisely the time of reaching the mechanical opening end stop, press the SS command.

Motor M2 starts automatically in opening mode. If motor M2 moves in closing, stop by pressing DOWN - and resume movement using SS (the leaf resumes movement in the correct direction)

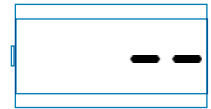

6. Motor M2 opens at low speed. **At precisely the time of reaching the mechanical opening end stop.** After a couple of seconds, motor M2 starts automatically in closing at full speed.

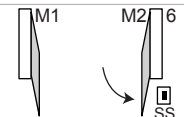
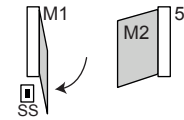

7. **On reaching the point where motor M2 closing deceleration is required, press SS.** M2 motor movement continues at low speed.

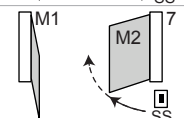

8. **Precisely when motor M2 reaches the closed position, press the SS command.** Motor M2 stops and motor M1 starts in closing.

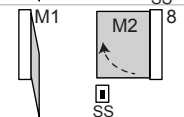

9. **On reaching the point where motor M1 closing deceleration is required, press SS.** M1 motor movement continues at low speed.

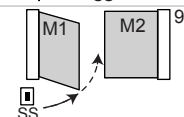

10. **Precisely when motor M1 reaches the closed position, press the SS command.** Motor M1 stops and restarts in opening.

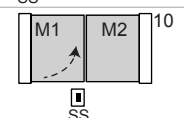

11. **On reaching the point where motor M1 opening deceleration is required, press SS.** M1 motor movement continues at low speed.

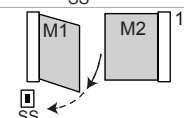

12. **Precisely when motor M1 reaches the open position, press the SS command.** Motor M1 stops and motor M2 starts in opening.

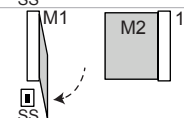

13. **On reaching the point where motor M2 opening deceleration is required, press SS.** M2 motor movement continues at low speed.

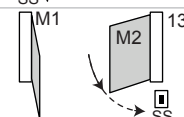

14. **Precisely when motor M2 reaches the open position, press the SS command.** Motor M2 stops.

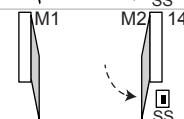

15. M1 and M2 resume closing according to the offset parameter entered in the menu, i.e. the gate closes automatically according to the set travel.



16. Run a number of opening, closing and stop manoeuvres, to check that the system is stable and there are no assembly defects.

All main parameters are configured as default by the control unit. To personalise installation, go to the next step in paragraph 4.4.

4.4 - Customising the system - BASIC MENU

If necessary, users may select a BASIC MENU which allows modification of the control unit's basic parameters. To select the BASIC MENU proceed as described below.

WARNING: to be certain of accessing the NORMAL OPERATION display state, the starting point for accessing the BASIC MENU, press the MENU key twice

Examplimg of modifying a BASIC MENU parameter



Press the MENU key for 1 second to access the basic menu.



After accessing the BASIC MENU, press the + and - keys to scroll through the functions.



To access the value modification function, press the MENU key for 1 second, until the value starts to flash quickly.



Press the + and - keys to modify the value.



Press the MENU key for 1 second to display the parameter in order to save the modified value, or MENU quickly to quit the function without saving.



Press the + and - keys to scroll through the functions to modify other parameters.



Press the MENU key quickly to quit the menu.

PARAMETERS	DESCRIPTION	DEFAULT CONFIGURATION	MIN	MAX	UNIT	
1	tCL	Automatic reclosing time (0 = disabled)	20	0	900	s
2	ttr	Reclosing after transit time (0 = disabled)	0	0	30	s
3	SEI	Obstacle sensitivity (0 = disabled)	0	0	100	% (steps of 1)
4	trq	Motor force (torque at operating speed)	100	10	100	% (steps of 10)
5	SSL	Deceleration mode 0 = deceleration 1/3 (slow) 1 = deceleration 2/3 (fast)	0	0	1	
6	Sbs	SS configuration: 0 = Normal (OP-ST-CL-ST-OP-ST...) 1 = Alternate STOP (OP-ST-CL-OP-ST-CL...) 2 = Alternate (OP-CL-OP-CL...) 3 = Apartment block - timer 4 = Apartment block with immediate reclosing	0	0	4	
7	bLt	Response after black out 0 = no action, as per before failure 1 = Closing	0	0	1	
8	SSt	Soft start (slow start-up) 0 = disabled 1 = enabled	0	0	1	
9	dLY	Second leaf delay	2	0	300	s
10	LSI	Deceleration range P = personalised from learning cycle 0...100% = travel percentage	15	0	100	% (steps of 1)
11	ASL	Anti-slip: extension of set work time (useful in areas subject to strong winds)	0	0	300	s
12	nnt	Number of motors 1 = 1 motor 2 = 2 motors	2	1	2	

4.5 - Connecting the radio receiver

Connect the radio receiver, removing the plastic cover and taking care to position it as shown in the diagram in point 2.1. For programming, follow the receiver instructions, remembering that

the 4 outputs which can be activated are:
OUTPUT 1 = STEP BY STEP, OUTPUT 2 = PEDESTRIAN, OUTPUT 3 = OPEN, OUTPUT 4 = CLOSE.

5 - TESTING AND COMMISSIONING THE AUTOMATION SYSTEM

The system must be tested by a qualified technician, who must perform the tests required by the relevant standards in relation to the risks present, to check that the installation complies with the

relevant regulatory requirements, especially the EN12445 standard which specifies the test methods for gate and door automation systems.

5.1 - Testing

All system components must be tested following the procedures described in their respective operator's manuals;

ensure that the recommendations in Chapter 1 - Safety Warnings - have been complied with;

check that the gate or door is able to move freely once the automation system has been released and is well balanced, meaning that it will remain stationary when released in any position;

check that all connected devices (photocells, sensitive edges,

emergency buttons, etc.) are operating correctly by performing gate or door opening, closing and stop tests using the connected control devices (transmitters, buttons or switches);

perform the impact measurements as required by the EN12445 standard, adjusting the control unit's speed, motor force and deceleration functions if the measurements do not give the required results, until the correct setting is obtained.

5.2 - Commissioning

Once all (and not just some) of the system devices have passed the testing procedure, the system can be commissioned;

the system's technical dossier must be produced and kept for 10 years. It must contain the electrical wiring diagram, a drawing or photograph of the system, the analysis of the risks and the solutions adopted to deal with them, the manufacturer's declaration of conformity for all connected devices, the operator's manual for every device and the system maintenance plan;

fix a dataplate with the details of the automation, the name of the person who commissioned it, the serial number and year of construction and the CE marking on the gate or door;

also fit a sign specifying the procedure for releasing the system by hand;

draw up the declaration of conformity, the instructions and precautions for use for the end user and the system maintenance plan and consign them to the end user;

ensure that the user has fully understood how to operate the system in automatic, manual and emergency modes;

the end user must also be informed in writing about any risks and hazards still present;

WARNING - after detecting an obstacle, the gate or door stops during its opening travel and automatic closure is disabled; to restart operation, the user must press the control button or use the transmitter.

6 - FURTHER DETAILS - ADVANCED MENU

The ADVANCED MENU allows the system to be further customised by modifying parameters not accessible from the basic menu

To access the ADVANCED menu, press the MENU key and hold it

down for 5 seconds

To modify ADVANCED MENU parameters, proceed as described for the BASIC MENU

PARAMETERS	DESCRIPTION	DEFAULT CONFIGURATION	MIN	MAX	UNIT
1	<i>EL.F.</i> Electric brake 0 = disabled 1 = enabled	0	0	100	x 0.01s (steps of 5)
2	<i>SP.h.</i> PHOTO1 response on start-up from closed 0 = PHOTO1 check 1 = the gate also opens if PHOTO1 is engaged	1	0	1	
3	<i>Ph.2.</i> PHOTO2 response 0 = Enabled in opening and closing OP/CL 1 = Enabled only in opening OP	0	0	1	
4	<i>tP.h.</i> Photo device test 0 = disabled 1 = PHOTO1 enabled 2 = PHOTO1 enabled 3 = PHOTO1 and PHOTO2 enabled	0	0	3	
5	<i>Ed.n.</i> Type of edge 0 = contact (NC) 1 = resistive (82k)	0	0	1	
6	<i>iE.d.</i> Edge intervention mode 0 = intervenes only on closing with inversion of direction 1 = stops automation (on opening and closing) and releases the obstacle (short inversion)	0	0	1	
7	<i>tE.d.</i> Edge test 0 = disabled 1 = enabled	0	0	1	
8	<i>LP.o.</i> Pedestrian opening	30	0	100	% (steps of 1)
9	<i>tP.C.</i> Automatic reclosing time from pedestrian (0 = disabled)	20	0	900	s
10	<i>FP.r.</i> Flashing light output configuration 0 = Steady 1 = Flashing	1	0	1	
11	<i>tP.r.</i> Pre-flash time (0 = disabled)	0	0	10	s
12	<i>FC.y.</i> Courtesy light configuration 0 = At end of manoeuvre, lit for time TCY 1 = Lit if gate is not closed + duration TCY 2 = Lit if courtesy light timer (TCY) not elapsed 3 = Gate open indicator on/off 4 = Gate open indicator proportional flashing	0	0	4	
13	<i>tCY.</i> Courtesy light duration	0	0	900	s (steps of 10s)
14	<i>dE.A.</i> Hold-to-run 0 = disabled 1 = enabled	0	0	1	
15	<i>SE.r.</i> Cycle threshold for assistance request. On reaching the set threshold the subsequent cycles will be performed with quick flashing (only if <i>FP.r.</i> is active). (0 = disabled)	0	0	100	x 1000 cycles
16	<i>SE.F.</i> Enabled in continuous flashing mode for assistance requests (function only enabled when gate is closed). 0 = disabled 1 = enabled	0	0	1	
17	<i>HA.o.</i> Water hammer on opening 0 = disabled	0	0	100	*100ms
18	<i>HA.c.</i> Water hammer on closing 0 = disabled	0	0	100	*100ms
19	<i>NP.r.</i> Interval for maintaining hydraulic motor pressure 0 = disabled from 1 to 480 enabled as follows: 1 = 1 min. ON and 1 min OFF, 2 = 1 min. ON and 2 min. OFF, ...	0	0	480	minutes
20	<i>dE.F.</i> Reset to default values				

To set the default values: 1) access the advanced programming function; 2) select the "dEF" parameter"; 3) activate the modification mode ("0" on display"); 4) accept the modification (press "MENU"

and hold it down). A countdown should now appear: d80,d79...,d01 down to "don". Release the key when finished.

7 - INSTRUCTIONS AND WARNINGS FOR THE END USER

Key Automation S.r.l. produces systems for the automation of gates, garage doors, automatic doors, roller blinds and car-park and road barriers. However, Key Automation is not the manufacturer of your complete automation system, which is the outcome of the analysis, assessment, choice of materials and installation work of your chosen installer. Every automation system is unique, and only your installer has the experience and skill required to produce a safe, reliable, durable system tailored to your needs, and above all that complies with the relevant regulatory standards. Although your automation system complies with the regulation safety level, this does not rule out the presence of "residual risk", meaning the possibility that hazards may occur, usually due to reckless or even incorrect use. We would therefore like to give you some advice for the correct use of the system:

- before using the automation system for the first time, have the installer explain the potential causes of residual risks to you;
- keep the manual for future reference, and pass it on to any new owner of the automation system;
- reckless use and misuse of the automation system may make it dangerous: do not operate the automation system with people, animal or objects within its range of action;
- a properly designed automation system has a high level of safety, since its sensor systems prevent it from moving with people or obstacles present so that its operation is always predictable and safe. However, as a precaution children should not be allowed to play close to the automation system, and to prevent involuntary activation, remote controls must not be left within their reach;
- as soon as any system malfunction is noticed, disconnect the electricity supply and perform the manual release procedure. Never attempt repairs on your own; call in your installation engineer. In the meantime the door or gate can be operated without automation once the geared motor has been released using the release key supplied with the system. In the event of safety devices out of service arrange for repairs to the automation immediately;
- in the event of malfunctions or power failures: while waiting for the engineer to come (or for the power to be restored if your system is not equipped with buffer batteries), the door or gate can be used just like any non-automated installation. To do this, the manual release procedure must be carried out;
- manual release and operation: first bear in mind that the release procedure can only be carried out with the door or gate stationary.

- Maintenance: Like any machine, your automation system needs regular periodic maintenance to ensure its long life and total safety. Arrange a periodic maintenance schedule with your installation engineer. Key Automation recommends that maintenance checks should be carried out every six months for normal domestic use, but this interval may vary depending on the level of use. Any inspection, maintenance or repair work must only be carried out by qualified staff.

- Never modify the automation system or its programming and setup parameters: this is the responsibility of your installation engineer.

- Testing, routine maintenance and any repairs must be recorded by the person who performs them and the documents must be conserved by the system's owner.

The only procedures you are capable of, and which you are recommended to perform, are cleaning of the photocell glass and removal of any leaves or stones that may obstruct the automation system. To prevent anyone from activating the gate or door, release the automation system before starting. Clean only with a cloth dipped in a little water.

At the end of its useful life, the automation system must be dismantled by qualified personnel, and the materials must be recycled or disposed of in compliance with the legislation locally in force.

If after some time your remote control seems to have become less effective, or stops operating completely, the battery may be flat (depending on the level of use, this may take from several months up to more than a year). You will realise this because the transmission confirmation light does not come on, or only lights up for a very short time.

Batteries contain pollutants: do not dispose of them with normal waste but follow the methods specified by the local regulations.

Thank you for choosing Key Automation S.r.l.; please visit our Internet site www.keyautomation.it for further information.